

# smART

ART MEETS STATE-OF-THE-ART



CAT/MS/01-18

## HPL Electric & Power Ltd

Corp. Office : Windsor Business Park, B-1D, Sector-10,  
Noida, U.P. - 201301, INDIA

Tel.: +91-120-4656300, Fax: +91-120-4656333

Registered Office : 1/21, Asaf Ali Road, New Delhi - 110 002, INDIA.

E-mail : hpl@hplindia.com; enquiry@hplindia.com

Customer Care No. : 18004190198

[www.hplindia.com](http://www.hplindia.com)



MODULAR SWITCH



MODULAR SWITCH

PRODUCT CATALOGUE



POWER OF TECHNOLOGY

Founded in 1956 and displaying an unwavering commitment to the creation of world-class quality products ever since, the HPL Group has created a niche for itself in the electrical industry. Today, HPL is regarded as "The Technology Brand of India" and is one of the premium manufacturers of reliable Electrical Protection Equipments, Switchgears, Electronic Energy Meters and Energy Management Systems. Consistent and sound policies have helped the HPL Group mark a strong presence nationally as well as globally.

A fast growing company that boasts of more than 2000+ dealers, HPL continuously keeps adding new products to its already impressive portfolio. Modular Switches are the latest addition to the range.

Social and environmental responsibility has been at the forefront of HPL's operating philosophy and the company consistently contributes to socially responsible activities.

Our geographical reach access across market segments and our ability to cater to new requirement of the customer with smart solutions makes us a multipolar group.

**HPL product profile's unparalleled domain expertise is reflected in the following strategic business units:**

- LV Switchgears
- LV Protection Devices
- Modular Switches
- Metering and Energy Management System
- Lighting
- Luminaries
- Wire & Cables
- Solar

HPL takes pride in its networking to support and augment the product line. HPL Group with its Head Office at New Delhi has extensive sales and marketing network of 90 Branch Office & Representative Office, over 2000+ Authorized Dealers and 27000+ retailers across the country, who are committed to provide solutions and services to customers' delight.

HPL is also expanding its horizon by exporting its products to Middle East, SAARC and European countries.

Social and environmental responsibility has been at the forefront of HPL operating philosophy and as a result the company consistently contributes to socially responsible activities. The essence of HPL success lies in the expertise of its fine team of professionals, strong relationship with associates and the ability to adopt quickly and efficiently coupled with the vision to always think ahead.





- Switches
- Controllers
- Connectors
- Sockets
- Skirting Light
- Indicators / Hospitality Range
- Metal Boxes
- Specialty Products
- Accessories





S W I T C H E S

S O C K E T S



Range:

6A/10A/20A/32A-DP Switch

Features

- ROHS compliance.
- Captive screws.
- Dual protection for spark shield.
- High grade flame retardant engineering plastic.
- Silver Nickel Contact for trouble free operations.

Material:

Polycarbonate-FR

Colours Available :

White, Black, Graphite

Dimensions:

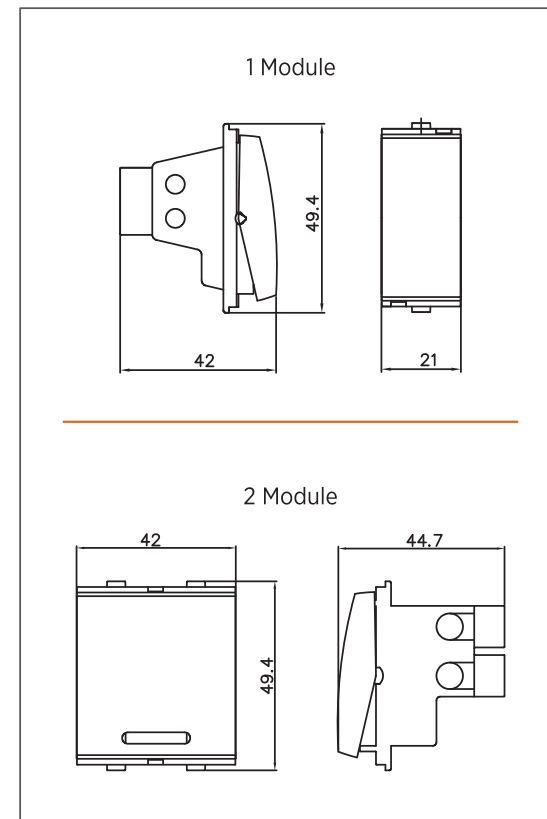

Range:

6A-5 pin/6A-2 pin/6-16A Pin sockets & 10-13A universal sockets.

Features

- Hardened phosphorus bronze contacts.
- High grade flame retardant engineering plastic.
- Each socket has a spring loaded protective safety shutter.

Material:

Polycarbonate-FR

Dimensions:

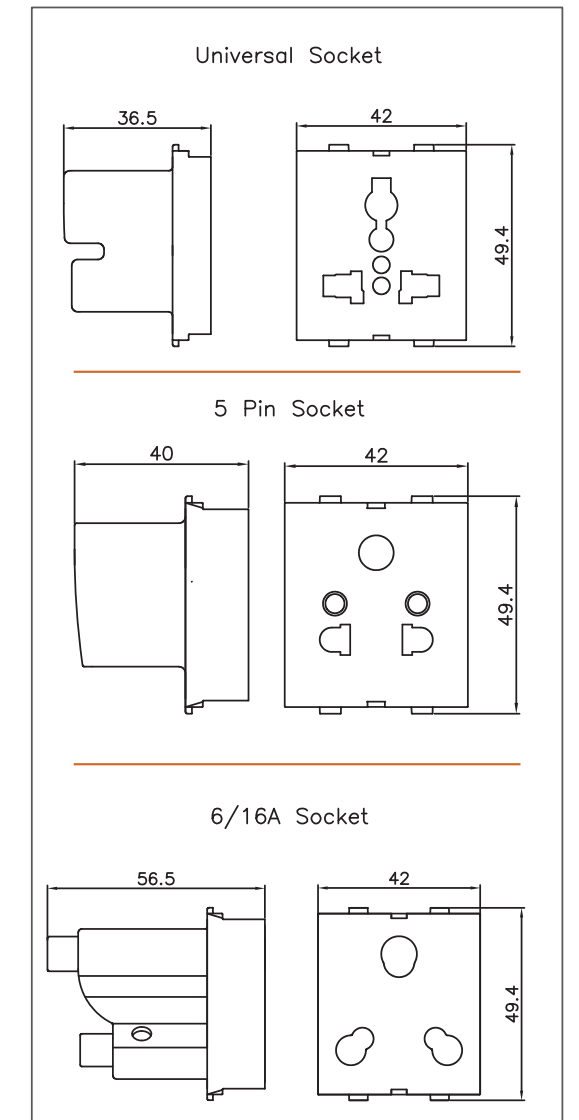



C O N T R O L L E R S

C O N N E C T O R S



Range:

Fan Regulator-step type 1 module/2 module  
 Dimmer-400 W/600W/1000W

Features:

- No radio frequency interference
- High grade flame retardant engineering plastic
- Good ventilation for proper heat dissipation.
- Easy to remove and install
- No humming noise

Material:

Polycarbonate-FR

Colours Available :

White, Black, Graphite

Dimensions:

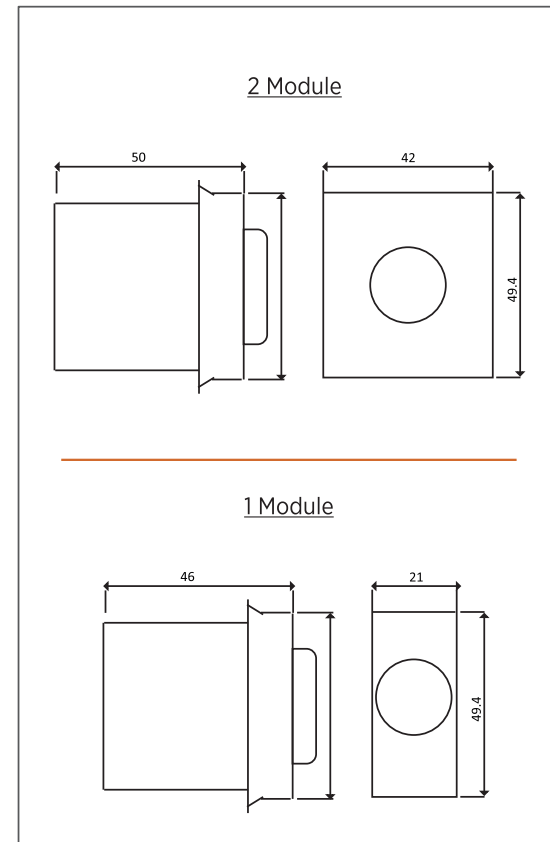

Range:

RJ-11,2-Line/4-Line/2-Line twin jack  
 RJ-45/RJ-45 Cat-6/Audio-DVD socket/Television

Features

- Contact material phosphor bronze
- Gold plated
- User friendly shutters
- Easy to remove and install

Material:

Polycarbonate-FR

Dimensions:

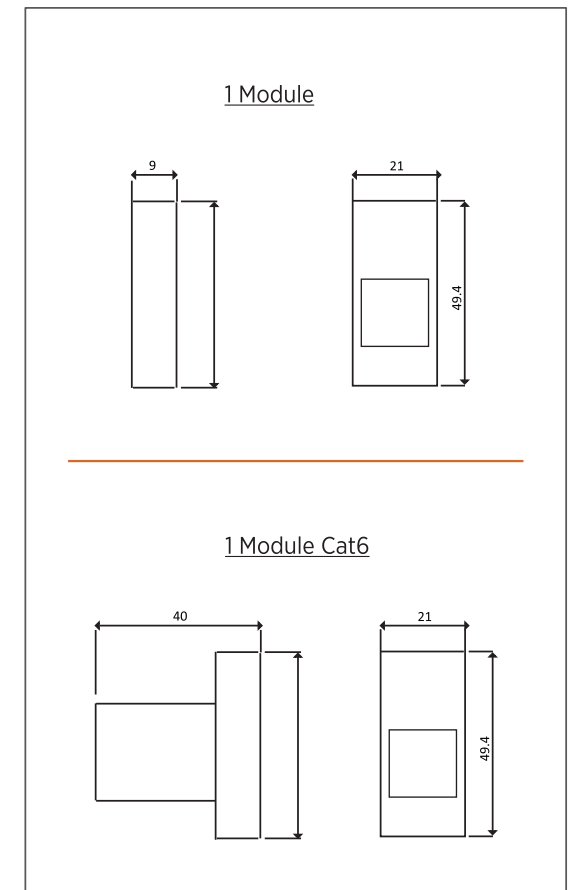



S P E C I A L I T Y P R O D U C T S

**SMOVENT DECTECTOR Wall mount:**

- Wall mount - 3 module
- Sensing distance : 20 to 30 feet
- Sensing angle 120 degree,
- Load - 1000 watts resistive or 300 watts Inductive or 100 watts CFL
- On time : adjustable from 2 to 37 minutes



**USB Charger**

- Size : 2 module
- Voltage (V) DC - 5V
- Output 2000mA
- Material : Polycarbonate (FR)



**Movement Dectector Ceiling:**

- Ceiling mount : Install. Ht - 12feet max.
- Adjustable : Lux sensor / On time
- Sensing distance - 40 feet diameter
- Load - 1000 watts resistive or 300 watts inductive or 100 watts CFL
- On time : adjustable from 2 to 37 min.



**AC Box with MCB**

- Size : 3 & 4 module, with MCB & Motor Starter
- Material : Polycarbonate (FR)
- 3M with MCB Rating: 20A Socket, 20A MCB, 20A Plug Top.
- 4M with MCB Rating: 25A Socket, 25A MCB, 25A Plug Top.
- 4M with Motor Starter: 20A Socket, 20A Motor Starter, 20A Plug Top.



**Remote Switch Standalone:**

- Channel 1,2 & 3
- Load/Ch - 1000 watts Res/300 watts Ind/100 watts CFL
- Channel 4 - Fan load : 100 watts max
- Dimming : 100 watts max. for Incandescent lamp
- Remote operating distance 25 ft. max at 120° angel



**Key Tag Switch:**

- Load 20 Amps 230 VAC Off Time Delay 30 Sec.















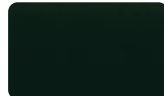

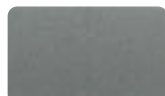
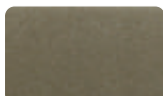

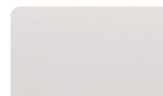

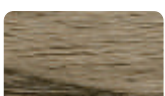

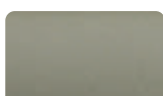

C O L O U R P L A T E S



Range of 21 Colour Option Available With 3 Exquisite Switches:

 Carbon Black	 Forest Green	 Bordeaux Red	 Corian Blanco Gray	 Briar	 Graphite Green
 Metalik Copper Flame	 Metalik Sterling Silver	 Metalik Vegas Gold	 Walnut Briar	 Bright White	 Dark Oak
 Charcoal Strips	 Light Oak	 Makore	 Saparkle Green	 Indescent Champagne	 Coffee Brown
 Orange Motion	 Floral White	 Midnight Blue			



H O M E S



O F F I C E



R E T A I L

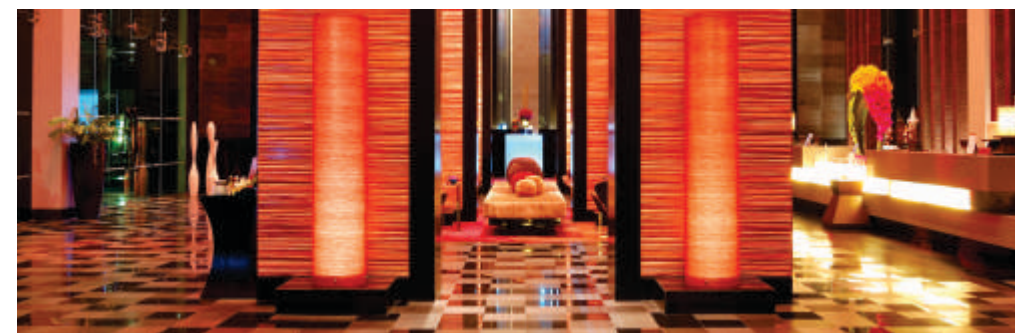

H O T E L S

Our Modular Switches boast a full range of attractive colours and elegant designs seamlessly fitting in any décor across homes, offices, retail and hospitality.



## INSTALLATION



Concealed metal box

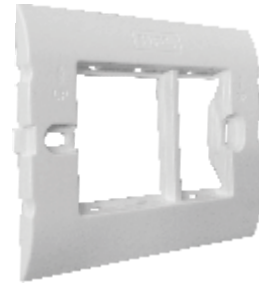

Mounting plate



Switch/socket

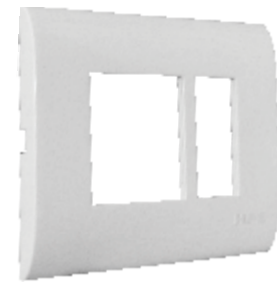

Front plate

## DISMANTLING

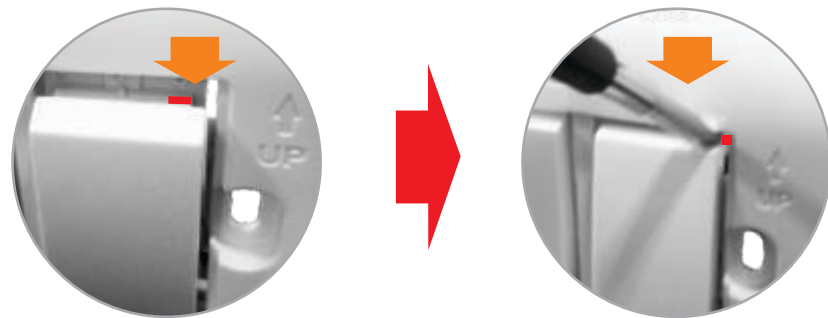

Locate the special 'Groove' at the right hand top corner. Insert flat head of a suitable screw driver into it and gently scoop out for removal.

## B R A N C H O F F I C E S

### AHMEDABAD

B-802, Iscon Elegance, Nr. Prahlad Nagar Corner, Opp. Karnavati Club, S.G. Highway, Ahmedabad-380 051  
Ph.: 079 - 66168835  
E-mail: ahmedabad@hplindia.com

### BANGALORE

No.2D, 11nd Floor, Farah Winsford, 133, Infantry Road, Bangalore - 560 001  
Ph.: 080-22863068/69  
E-mail: bangalore@hplindia.com

### BHUBANESWAR

N3-135, IRC Village, Nayabali, Behind Old Sai Baba Temple, Bhubaneswar-751 012 Ph.: 0674-2550826  
E-mail: orissa@hplindia.com

### CHANDIGARH

Plot No. 57, 5th Floor Industrial & Business Park, Phase-1 Chandigarh - 160002 Ph.: 0172-2639157  
E-mail : chandigarh@hplindia.com

### CHENNAI

"Amar Sindur" S-4, 2nd Floor, No.-43, Pantheon Road, Egmore, Chennai-600 008  
Ph.: 044-28551530, 28551537  
Fax : 044-42638243  
E-mail: chennai@hplindia.com

### COCHIN

1st Floor, A.K.S. Mahal Building, XL/7813J, Achutha Warriar Lane, M.G.Road,Ernakulam,Cochin-682 035  
Telefax : 0484-2354595  
E-mail: cochin@hplindia.com

### COIMBATORE

Designer Complex, Door No.130, C /2, 2nd Floor, Dr. Nanjappa Road, Coimbatore - 641018  
Ph.:0422-4393995  
E-mail : coimbatore@hplindia.com

### DEHRADUN

09/4/6, 1st Floor, East Canal Road, (Near Doon Defence Academy) Dehradun-248001  
Ph.: 0135-2710567, 2710587  
E-mail: Uttranchal@hplindia.com

### GUWAHATI

Rajgarh Road, Opposite China Town Restaurant Guwahati - 781 003  
Ph.: 0361-2450889  
E-mail: guwahati@hplindia.com

### HUBLI

9-10, 1st Floor, Vernekar Plaza, Desh Pande Nagar, Hubli-580029  
Ph.: 0836-4251463  
E-mail : hubli@hplindia.com

### HYDERABAD

No. 7-1-58, flat No.403, 4th Floor, Concourse Building, Green Lands Road, Hyderabad - 500 016  
Ph.: 040-40035959  
E-mail: hyderabad@hplindia.com

### INDORE

203, Millinda Manor 2 RNT Marg, Near Ravindra Natya Grah, Indore- 452 001,  
Ph.: 0731-4280525, 4225540  
E-mail: Indore@hplindia.com

### JAIPUR

512, 5th floor, Plot No. 8-9, Corporate Park, Gopal Bari, Ajmer Road Jaipur - 302 001  
Ph. : 0141-4021035  
E-Mail: jaipur@hplindia.com

### JAMMU

Plot No.86 Yard No.6 Transport Nagar, Jammu- 180006  
E-mail: jammu@hplindia.com

### KANPUR

17/14, 2nd Floor, Opposite Nanarao Park, The Mall, Kanpur - 208 001 (U.P.)  
Ph.: 0512-2316017  
E-mail: kanpur@hplindia.com

### KOLKATA

69, Ganesh Chandra Avenue, India House 7th Floor, Block-C, Kolkata - 700 013  
Ph.: 033-65394379  
E-Mail: calcutta@hplindia.com

### LUCKNOW

1st Floor, Jain Building, 14/A5, Park Road Hazratganj ,Lucknow  
Ph.: 0522-4021687  
E-Mail: lucknow@hplindia.com

### LUDHIANA

698 - D, Model Town, Extn., Opp. silverstone Hotel, Ludhiana-141 003  
Ph. : 0161-4062877  
E-Mail : ludhiana@hplindia.com

### MUMBAI

2C/H, Rushabh Chambers 2nd Floor, Off-Makwana Road, Near Rubi Hotel Marol Andheri East Mumbai - 400 059  
Ph.: 022-61830810-20 Telefax: 022-28528181  
E-mail: mumbai@hplindia.com

### NAGPUR

Jagtap House, Plot No. 07, 1st Floor, Ganesh Gruh Nirman Society, Near Ganesh Mandir, Ring Road, Pratap Nagar, Nagpur - 440022,  
Ph.: 0712-2222988  
E-mail: nagpur@hplindia.com

### PATNA

Hem Plaza, 5th Floor - 510 Frazer Road, Patna - 800001(Bihar)  
Ph. : 09334697299  
E-mail: patna@hplindia.com

### PUNE

Sunrise Skyline 3rd Floor, Plot No. 28/2 Scheme No. 11 B Opp. MSEB Office Somwar Peth Pune - 411 001 Ph. : 020-69200902  
E-mail: pune@hplindia.com

### RAIPUR

1st Floor, Near Holy Heart School Chattisgarh College Road, Civil Line, Raipur (C.G.)-492 006 Ph.:0771-6541590  
E-mail : raipur@hplindia.com

### RANCHI

203, Mahalaxmi Complex, Line Tank Road, 2nd Floor Ranchi - 834 001  
Telefax : 0651-2206144  
E-mail : ranchi@hplindia.com

### SILIGURI

1st Floor, Parasuna Bhawan, Ward No.13, Udham Singh Sarani, Asram Para, Siliguri-734001

### VADODARA

409/410, Silver Oak Complex, Near Sainik Park Char Rasta, Productivity Road, Akota, Vadodara - 390020 Gujarat  
Ph.: 0265-2341747 Fax:0265-2352107  
E-mail : baroda@hplindia.com

### VIJAYAWADA

D.No.-29-37-135, 2nd Floor, G. R. Plaza, Eluru Road, Beside Canara Bank, Vijayawada-520 002  
Ph.: 0866-6622291  
E-mail : vijayawada@hplindia.com

### VIZAG

B.K. Towers, 49-34-1/63, 3rd Floor Akka Yapalem Main Road, NH-5 Junction, Vizag-530 016 (A.P.)  
Ph.: 0891-2794506  
E-mail : vizag@hplindia.com

### Resident Offices:

Agartala	Balasure	Davangere	Jharsuguda	Moradabad	Silchar	Vapi
Agra	Belgaum	Durg	Jodhpur	Mysore	Surat	Varanasi
Allahabad	Berhampur	Goa	Kanyakumari	Nagerkoil	Sholapur	Vellore
Anantpuram	Bhilai	Gorakhpur	Kolhapur	Nasik	Srinagar	
Aurangabad	Bhopal	Gulbarga	Kota	Patiala	Sambalpur	
Amravati	Bilaspur	Jabalpur	Madurai	Pondicherry	Tirupati	
Akola	Bijapur	Jabli	Malda	Rajkot	Trichy	
Angul	Calicut	Jamshedpur	Mangalore	Rourkela	Trivandrum	
Bareilly	Cuttack	Jalandhar	Meerut	Salem	Udaipur	

